

**CATER-ICE**

# Cube Ice Machine - Instruction Manual

Models: CK8036, CK8055 & CK8095 Self Contained Ice Makers



To avoid risk of accidents or damage to the appliance, it is essential to read these instructions before the unit is installed and used for the first time.



## Caterkwik Ltd

The Lakeland Catering Centre  
Newlands  
Ulverston  
Cumbria  
LA12 7QQ

01229 480001

[info@caterkwik.co.uk](mailto:info@caterkwik.co.uk)





## Introduction

Thank you for purchasing the Cater-Ice Commercial Ice Maker. Please read these instructions carefully, correct maintenance and use of your Cater-Ice product will provide the best possible performance and reliability.

### **WARNING!**

Please pay attention to the following warning labels on the ice maker:

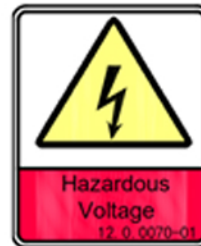

These labels indicate a hazardous voltage. Please handle electrical components with care. Misuse may result in an electric shock.

The following label indicates rotating components inside. Please do not attempt to handle rotating components as serious injury could occur:

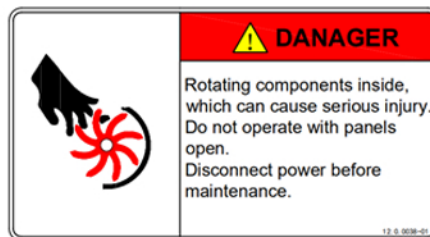

The following labels indicate that a flammable foaming agent 'Cyclopentane' and a flammable refrigerant 'R290' are used inside the ice machine. Keep open flames and combustible aerosols away from the ice maker to avoid risk of fire.

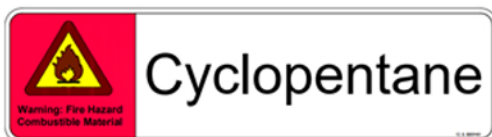

# Ice Maker - Instruction Manual

## Safety Instruction



### Instruction of Symbols in this Manual



Warning sign,  
special attention is required.



Warning sign,  
special attention is required and operation  
is prohibited.

### Warning and Safety Instruction



**This ice machine cannot be used in an outdoor environment.**

**This ice machine is NOT intended for use by children, people with reduced physical, sensory or mental capabilities or lack of experience unless supervised by a person responsible for their safety.**

- The installation, repair or maintenance of this ice machine must be carried out by professional and qualified personnel. Injury or a safety risk may be a result of incorrect operation.
- When the ice machine has been delivered, please keep the machine still and upright with the inclination not exceeding 45°. Do not invert the machine or horizontally.
- This ice machine should not be placed in a wet or easily splashed area.
- The grounding of this machine cannot be connected to gas pipe, water pipe, telephone line or lighting conductors, etc.
- The ice machine contains rotating components. Do not insert slim objects into the ventilation or the exhaust ports, as serious mechanical damage may occur.
- Do not store volatile or flammable substances in this ice machine to prevent the risk of a fire or explosion.
- Do not store any sundries or freeze any food in the ice bin. Ensure the ice scoop is always kept clean.
- The ice machine must always be placed on a floor which is capable of supporting its weight. Ensure the ice machine is always kept level to avoid the machine falling over. This will allow the machine to operate efficiently.
- There should be sufficient ventilation space around the ice machine. Allow 50mm of space.
- Only the power supply specified on the machine data plate can be used to operate the ice machine.

# Ice Maker - Instruction Manual

## Safety Instruction



### Warning and Safety Instruction

- This ice machine cannot be connected to the hot water supply.
- The electrical socket used for this ice machine must be reliably grounded and have sufficient protection from potential leakage.
- The ice machine must be disconnected from the power before manual cleaning, repair and maintenance.
- Before cleaning, repairing and maintenance, any remaining ice in the ice bin should be removed to avoid contamination to the ice.
- Do not splash water directly onto the surface of the ice machine during the cleaning process as this may cause the machine to short circuit, leak or cause other faults to occur.
- Flammable foaming agent is used in the ice machine. The ice machine should be disposed of and recycled by qualified personnel and institutions.
- If there is a problem or malfunction with the ice machine, turn the power OFF and contact Caterkwik on the contact details below.



### This ice machine contains flammable refrigerant R290

**CAUTION** - Risk of fire or explosion. Flammable refrigerant used. **DO NOT** use mechanical devices to defrost the ice machine. **DO NOT** puncture the refrigerant tubing.

**CAUTION** - Risk of fire or explosion. Flammable refrigerant used. To be repaired **ONLY** by trained service personnel. **DO NOT** puncture the refrigerant tubing.

**CAUTION** - Risk of fire or explosion. Flammable refrigerant used. Consult repair the user manual before attempting to service this product. **ALL** safety precautions must be followed.

**CAUTION** - Risk of fire or explosion. Flammable refrigerant used. Dispose of properly in accordance with local laws and regulations. Handle carefully, following all safety precautions.



## General

This ice machine is fully automatic. With proper installation and connection to potable water and adequate power source, the ice machine will start production of ice.

When the ice cubes fill up the ice bin, the machine will automatically stop when the bin capacity is reached. The ice machine is generally used in the following:

- The kitchen / facility area of a shop, office or other workplace.
- Hotel, restaurant or other catering establishments.
- This ice machine is not intended for domestic use.

## Installation

### Location for Installation

The ice machine should be installed in a suitable location meeting the following conditions:

- Indoor, not more than 2,000 metres above sea level.
- Ambient temperature between 5 and 40°C.
- Power supply: the rated voltage indicated on the machine data plate.
- The ice machine should be kept away from heat sources and should not be situated where the temperature exceeds the recommended ambient temperature. i.e. Avoid very low and very high temperatures. Do not situate the ice machine in direct sunlight.
- There should be sufficient ventilation space around the ice machine. Allow for a minimum distance of 50mm between the ice machine and adjacent walls or objects.
- The ice machine must be placed on a floor sufficient to support its weight and ensure that the machine is level.
- The plug socket connected to the ice machine must be reliably grounded and contain adequate leakage protection.
- Proper floor drainage must be provided near the installation location of the ice machine.

## Ice Maker - Instruction Manual Installation Diagram

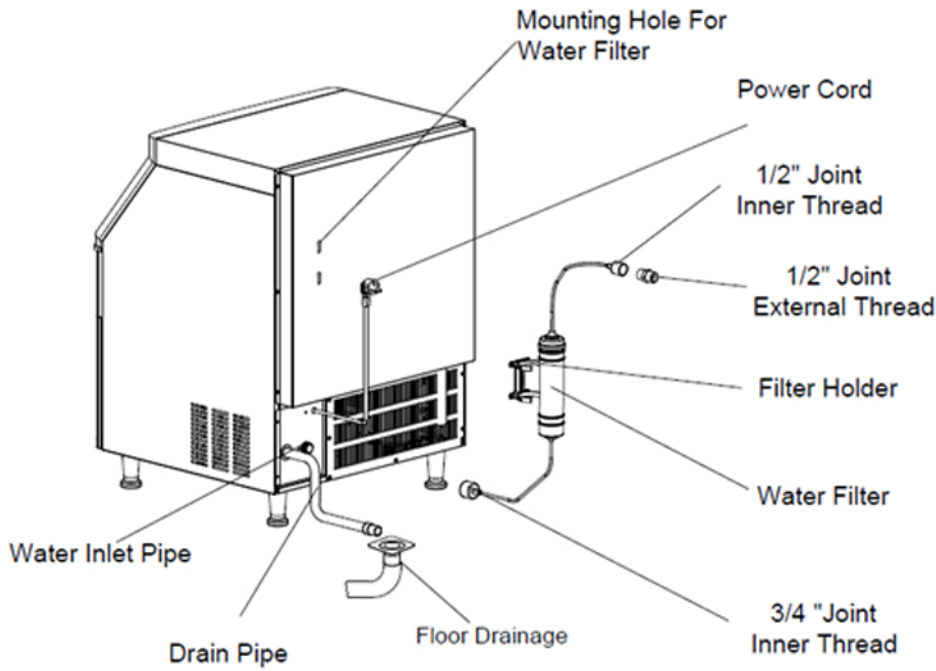

# Ice Maker - Instruction Manual

## Installation Steps



1. Check if the ice machine is in good condition and complete with included accessories. Check the machine model and the machine data plate.
2. Clean the ice bin with a cloth soaked in warm water and suitable cleaning solution. Thoroughly wash with potable water then leave to dry.
3. Ensure that the place where the ice machine is to be installed has a leveled floor. This will allow the water to flow evenly on the evaporator.
4. The compressor and condenser are located at the back of the ice machine. Good ventilation is required for an air cooled unit. Ensure the front and back of the ice machine has a minimum gap of 50mm.
5. The bottom of the ice machine is equipped with adjustable legs for level adjustment and floor cleaning.
6. Connect the inlet water filter and water pipe referring to the installation diagram.

 **Note: The filter flow direction should be correctly installed as per the direction marker on the filter head cover or the filter body.**

 **Note: This machine is equipped with an inlet water filter. The filter will prevent impurities from the main water being used to make ice. It is recommended to be replaced every 1-3 months, depending on how heavily the ice machine has been used. THIS IS NOT A HARD WATER SOLUTION.**

7. Connect the machine to the water supply using the 3/4" inlet pipe supplied with the machine. It is recommended to install a water valve (not supplied with this machine) on the water supply pipe.
8. Connect the drain pipe to the drain connection. For the machine to drain efficiently, it is recommended that the drain pipe should not exceed a level difference more than 30mm per metre. Ensure that the drain pipe is not blocked. It is recommended that the drain pipe is connected to an open drainage port.
9. Drain pipe joints must NOT be higher than the ice machine drain outlet. A drain pipe joint cannot be located higher than the previous joint.
10. Confirm the power requirements stated on the machine data plate. Ensure that the power supply meets the requirements.
11. A circuit breaker or switch with leakage protection and reliable grounding is required.
12. Turn off the switch at the plug socket before connecting the machine to the power source.

# Ice Maker - Instruction Manual

## Start Up & Operation



### 1. Before you start up the machine, please check and ensure:

- All the packaging tape inside the machine has been fully removed.
- The accessories and items inside the ice bin have been taken out.
- The ice machine is situated on a level surface.
- The water pipe is connected, and the water valve is open.
- The plug is connected to the power supply.
- The ambient temperature, water temperature, and pressure of the water supply meet the requirements stated previously.

### 2. To start up the ice machine: Turn on the power switch. After the ice machine powers on, ice will automatically start to be produced.

### 3. For normal operations please ensure:

- There is water in the water trough and no overflow occurs.
- The pump is working properly, and water is flowing evenly on the evaporator.
- The compressor is running normally, and that the temperature of the evaporator and the water being used to make the ice is gradually decreasing (getting colder)
- Check the fan is running normally, and there is a consistent, stable air flow in the inlet and outlet of the machine.
- The ice machine is making no abnormal noises or vibrations.
- It takes about 10-20 minutes to make one batch of ice, depending on the ambient temperature and the temperature of the water. The higher (hotter) the temperature is, the longer it will take to make the ice.
- Ice cubes are properly being harvested from the machine.



# Ice Maker - Instruction Manual

## Operation Instruction



- **Startup:** Once the machine has properly been installed, connect the water source and turn on the power supply, the machine will turn on and start working. Please check that the machine is operating normally when you turn it on for the first time. Refer to page 7.

 **Note: In case of a thunderstorm or if the ice machine is not in use for a long time, please disconnect the power and water sources.**

- **Self-check:** When powered on for the first time, the ice machine will do a self-check and pump out excess water.
- **Water in:** After machine is powered on, the inlet valve will open. Water will enter the machine until it reaches a certain level.
- **Ice making:** After pre-cooling for 30 seconds, the water pump will start. Water will flow through the evaporator smoothly and evenly and gradually; ice cubes will form in the ice tray.
- **Ice Harvest (Drop):** Following the ice production process, the water pump will turn off. The defrost valve will turn on, allowing the hot gas refrigerant to enter the evaporator for about 1-2 minutes. Ice cubes will slide from the evaporator for about 1-2 minutes. Ice cubes will slide from the evaporator into the ice bin.

 **Warning: Do not put your hands into the ice bin during the harvest process.**

- **Shutdown:** The ice machine will stop working if the "on / off" button on the panel is pressed during operation.
- **Bin full stop:** Once a certain amount of ice has been deposited in the bin and it has reached a certain height, the ice machine will stop in 40 seconds and enter a standby phase.
- **Repeat ice-making:** Once the ice in the ice bin has been partly or fully removed, the ice machine will begin producing ice again after a few seconds.

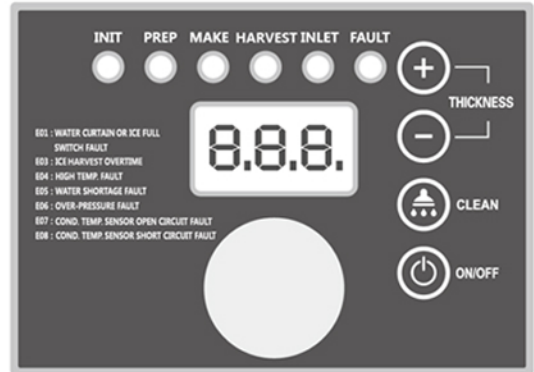

### LED Display

- Self-check: "INI" code will be displayed.
- Preparing: Numbers will be displayed indicating the number of seconds.
- Ice making: Numbers will display indicating the seconds required for the water temperature to decrease to 0°C.
- Ice Harvest: Numbers will be displayed indicating the number of seconds.
- Clean: "CLE" will be displayed during cleaning and descaling. "STL" will display during sterilizing. "RIN" will display during rinsing.

1. LED Lamps: Lights will illuminate when the related process is in operation.

2. Ice cube thickness adjustment: During the ice making process to adjust the ice thickness, press the "\_ " button for 3 seconds, then click either "+" or "-" on the panel to adjust the thickness of the ice cube.

 **Note: By clicking the "+" or "-" button one time, the ice making time is extended or shortened by 1.5 minutes.**

3. Cleaning: During normal operation, hold the cleaning button for 3 seconds to enter the cleaning cycle. During the cleaning cycle, cleaning solution and disinfectants will need to be put into the water trough. When the cleaning cycle has finished, the ice maker will return to the ice making process. Please dispose of the first couple of batches of ice that are made to ensure all cleaning solutions / disinfectants have been flushed from the water.

4. Switch: When the ice machine is powered, press the ON / OFF button to turn the ice machine on or off.

5. Please open and close the ice bin door gently. Ensure the bin door is closed securely after the ice cubes have been collected.

6. If the ice maker is not in use for a prolonged period, it should be energized and run for 2-4 hours every month.



**Error Displays**

Code	Fault Description
E01	Water Curtain or Ice Full Switch Fault.
E03	Ice Harvest Overtime.
E04	High Temp. Fault.
E05	Water Shortage Fault.
E06	Over-Pressure Fault.
E07	Cond. Temp. Sensor Open Circuit Fault.
E08	Cond. Temp. Sensor Short Circuit Fault.
E09	Water Temp. Sensor Open Circuit Fault.
E10	Water Temp. Sensor Short Circuit Fault.
E13	Water Level Control Fault.

**Other special protection - shutdown**

- If the ice machine does not detect any ice being harvested for three cycles, it will shut down to protect the machine. The ice machine will then need to be checked by a qualified engineer.
- If the ice machine detects the ambient temperature is too high, the machine will stop.
- The table to the left contains error codes the machine can display and the fault description.



**Note:** Maintenance must be carried out by a qualified engineer.



**Warning:** Before starting any maintenance or manual cleaning, ensure that the water source and power supply are disconnected from the ice machine.

## Exterior Cleaning

- Frequently clean the environment around the ice machine to keep it clean. Do not block the vents.
- The outer surface should be cleaned with a mild detergent and then wiped clean. Commercial stainless steel cleaners and polishes may be used.



**Note:** Stainless steel may rust without proper maintenance.

## Inlet Water Filter

- The water filter should be checked regularly. It is recommended to replace the filter every 1 to 3 months depending on usage.

## Interior Cleaning

- The interior of the ice storage bin can be washed directly with water.



**Note:** Ensure the water pressure is lower than the maximum allowed pressure supply to the ice machine. Do not flush the part above the water pump or the evaporator directly to avoid damage to these components.

## Condenser

- It is recommended that the condenser is cleaned every three weeks. Use a soft brush or a low powered vacuum cleaner with a brush end to clean the condenser. Only clean up and down along the fin direction to avoid damaging the fins. Misuse can affect the ice machine cooling.



## Condenser

- The condenser filter should be cleaned every 2 weeks.



**Note: Be careful when cleaning the condenser as the edges of the fins are sharp.**

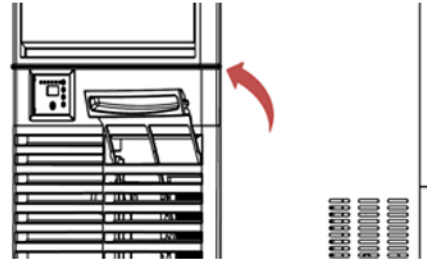

## Water Pipe

- In order to ensure the quality and the hygiene of the ice, the water pipe of the ice machine should be cleaned regularly.

## Prolonged Inactivity / Wintering

- If the ice machine is not used for a long period of time, ensure that the water and power supply are turned off and drain all residual water from the water trough, inlet pipe and drain pipe.



**The maintenance of the ice machine is not covered by the manufacturers warranty!**

## Clean Function



**Note: Fully empty the bin of all the ice.**



**Note: Clean and sterilize the bin. Make sure the bin is thoroughly rinsed afterwards.**



**Note clean and sterilize the ice sliding board, water distribution pipe, water supply pipe, water pump and rinse thoroughly.**

- Turn the ice maker on. Press the “clean” button for 3 seconds. This will initiate the the cleaning cycle. Manually add a suitable amount of cleaning solution.
- Manually add a suitable amount of cleaning solution and press the “clean” button again. When the auto clean has finished, the LED display will flash “clean” slowly. The ice machine will then begin a rinsing cycle for 5 cycles, this will take approximately 5 minutes per cycle. After this has completed, drain the water from the water trough.
- After the cleaning cycle has finished, it is optional to run the cleaning cycle again, this time adding a suitable amount of sterilizing solution. The ice machine will auto sterilize for 15 minutes after the clean button is pressed. When the auto sterilize has finished, the LED display will flash “clean” slowly. The ice machine will then begin a rinsing cycle for 5 cycles, this will take approximately 5 minutes per cycle.
- To ensure the ice machine is fully sterilized, spray the evaporator with a suitable cleaner.
- The ice machine will begin producing ice again as soon as the cleaning and rinsing cycle have finished. Ensure the first few batches of ice are thrown away and not used.

# Ice Maker - Instruction Manual

## Service Call



If the ice machine is working abnormally, please confirm the following before inquiring about a service call.

### 1. Check the water supply

- Check there is water in the water trough.
- Check the water pressure for the ice machine is between 1.3 - 5.5 Bar and that the water temperature is between 5 and 35°C.
- Check whether the water valve is open.
- Check whether there is no water leakage.

### 2. Check the power

- Check whether the display is showing OFF.
- If the LED on the display panel is blank or "OFF", check to see if the plug is correctly in a working socket whether the power supply is on.

### 3. Check the data plate and serial number

- Check the data plate located on the side or back of the ice machine and record the model and serial



**Note:** Faults with the ice machine that are deemed to be user error, such as no supply of water / electricity or environmental factors will be chargeable.



### Common Faults and Troubleshooting

Fault	Potential Cause	Troubleshooting
Ice machine is not working.  Indicator light is "OFF".	Power switch not turned on.  Plug is loose / not in the socket properly.	Turn on the power switch.  Check plug and socket.  Check the fuse.
The display shows E04 high temp.  The display shows E06 high pressure protection.	The ambient temperature is too high.  Condenser or air filter is dirty and blocked.  High pressure switch wires fallen off.  Fan does not start.	Normal working temp range is 5 - 40°C, ensure the ice machine is located within this range.  Clean the condenser and air filter.  Check and correct high pressure switch wires. Replace if required.  Check and correct the fan. Replace if required.
Ice defrost abnormal.	Ambient temperature too low.  Defrost valve does not start normally.  Ice thickness too thin or too thick.	Normal working temperature is between 5 and 40°C. Ensure the ice machine is located within this range.  Check and correct the defrost valve.
Poor transparency of ice cubes, ice cubes too thin or incomplete	Ice thickness too thin.  Water pressure too low.  Water temperature too high.  Inlet water valve is dirty and blocked  Water leaking.  Inlet water filter has not been replaced for a long time.	Adjust the ice thickness setting.  Adjust the ice thickness setting.  Check that the water pressure is 1.3 - 5.5 Bar.  Check and correct the inlet water valve. Replace if required.  Clean the inlet water valve.  Check whether water leaks and correct.  Check and correct the inlet water filter, replace if required.



### Common Faults and Troubleshooting

Fault	Potential Cause	Troubleshooting
Too slow making ice.	<p>The condenser or air filter is dirty.</p> <p>High ambient temperature.</p> <p>Poor ventilation.</p> <p>Water temperature is too high.</p>	<p>Clean the condenser and filter screen.</p> <p>Normal working temperature range of 5 - 40°C. Ensure the ice machine is located within this range.</p> <p>Check the environment around the ice machine. Ensure a minimum gap of 50mm is left around the vents.</p> <p>Check the water supply temperature of 5 - 35°C.</p>
Too much noise.	The ice machine is not placed on a leveled surface / ice machine is not leveled.	Level the ice machine.

### Warranty

The following are not covered by the warranty:

- Routine cleaning and / or maintenance.
- Unauthorized modification of the ice machine or use of non- manufacturer parts.
- Damage caused by improper power supply, water supply and drainage.
- Damage caused by installing, cleaning or maintaining the ice machine not in accordance with the instructions of this manual.
- Artificial damage.

Please contact Caterkwik for detailed information on what is / isn't covered under the warranty on 01229 480001

Service of this ice machine should only be carried out by a certified refrigeration engineer or Caterkwik.

Note this manual is subject to any technical change without further notice. Please refer to the data plate on the product for exact information.



**Disposing**

When the machine is not able to be repaired. You **MUST** cut off the power and dispose of the unit in accordance to your local council requirements.

In accordance with the 2002 / 95 / EC, 2002 / 96 / EC and 2002 / 108 / EC, certain hazardous substances are not allowed to be used on electronic equipment.

The below symbol on a product or on its packaging indicates that the product **MUST NOT** be disposed of with your other household waste.

Separate waste collection of this appliance is organised and managed by the manufacturer. It is the user's responsibility to contact the manufacturer and follow the waste treatment system the manufacturer has adopted for separate waste collection. The separate collection and recycling of your waste equipment at the time of disposal will help to conserve natural resources and ensure that it is recycled in a manner that protects human health and the environment.

